

N.rev. / Rev. N.	Descrizione / Description	Data / date	Firma / Sign	Contr. da / Ckd. by
------------------	---------------------------	-------------	--------------	---------------------

MXL Pista pinout

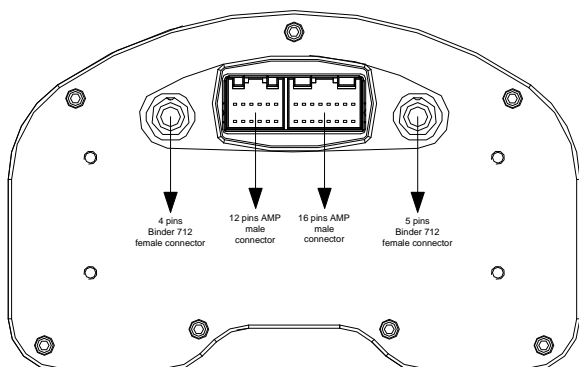



4 pins Binder 712 female connector pinout - Beacon	
Pin	Function
1	Magnetic Lap
2	GND
3	+VB
4	Optical Lap

12 pins AMP male connector pinout	
Pin	Function
1	GND
2	External power 9-15 V
3	CAN 1- ECU interface
4	CAN 1+ ECU interface
5	RS232TX
6	RS232RX
7	USB D-
8	RPM 150-400V coil and RPM square wave (>8V)
9	+VB
10	GND
11	+VB
12	Speed

16 pins AMP male connector pinout	
Pin	Function
1	Analog channel 4
2	V Reference
3	Analog GND
4	Analog channel 3
5	Analog channel 2
6	V Reference
7	Analog GND
8	Analog channel 1
9	Analog channel 8
10	USB D+
11	Analog GND
12	Analog channel 7
13	Analog channel 6
14	V Reference
15	Analog GND
16	Analog channel 5

5 pins Binder 712 female connector pinout - Exp	
Pin	Function
1	Can 0+
2	GND
3	+VB
4	Can 0-
5	Vb ext (9-15 VDC)

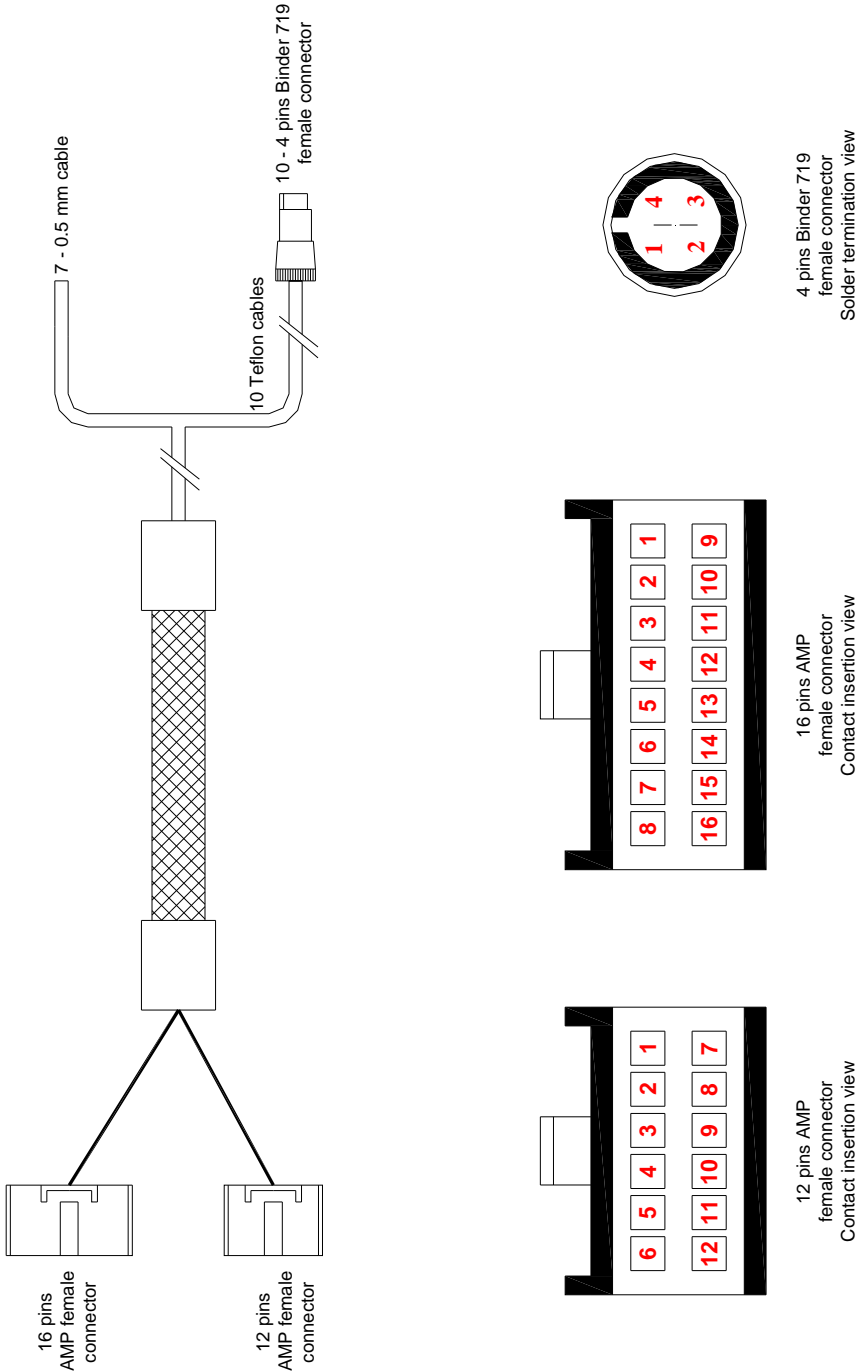
Rif. / Ref.	Q.tà / Q.ty	Materiale / Material	N. articolo / Item N.			
Progettato da / Designed by L.I.		Contr. da / Ckd. by	Approvato da / Approved by	Nome file / File name	Data / Date	Scala / Scale
 Racing Data Power		Titolo / Title Pinout MXL Pista				
		N. disegno / Drawing N.			Rev. / Rev.	Foglio / Sheet 1 of 1

N.rev. / Rev. N.		Descrizione / Description		Data / date	Firma / Sign	Contr. da / Ckd. by
<p>Cable standard for MXL Pista and optional for MXL Strada</p> 						
Rif. / Ref.	Q.tà / Q.ty	Materiale / Material		N. articolo / Item N.		
Progettato da / Designed by L.I.	Contr. da / Ckd. by	Approvato da / Approved by	Nome file / File name	Data / Date	Scala / Scale	
 Racing Data Power		Titolo / Title Cavo standard per MXL Pista ed optional per MXL Strada				
		N. disegno / Drawing N. 04.554.02		Rev. / Rev.	Foglio / Sheet 1 of 3	

N.rev. / Rev. N.	Descrizione / Description	Data / date	Firma / Sign	Contr. da / Ckd. by
------------------	---------------------------	-------------	--------------	---------------------

Binder 719 connector Table

Channel	Binder pin	Cable Colour	AMP 12 pin	AMP 16 pin	Connection	Length
Ch. 1	1	White		8	Analog input 1	350 mm
	2	Black		7	Analog GND	
	3	Red				
	4	Blue		6	V reference	
Ch. 2	1	White		5	Analog input 2	350 mm
	2	Black		7	Analog GND	
	3	Red				
	4	Blue		6	V reference	
Ch. 3	1	White		4	Analog input 3	350 mm
	2	Black		3	Analog GND	
	3	Red				
	4	Blue		6	V reference	
Ch. 4	1	White		1	Analog input 4	400 mm
	2	Black		3	Analog GND	
	3	Red	9		+ VB	
	4	Blue		2	V reference	
Ch. 5	1	White		16	Analog input 5	400 mm
	2	Black		15	Analog GND	
	3	Red	9		+ VB	
	4	Blue		2	V reference	
Ch. 6	1	White		13	Analog input 6	400 mm
	2	Black		15	Analog GND	
	3	Red	9		+ VB	
	4	Blue		2	V reference	
Ch. 7	1	White		12	Analog input 7	450 mm
	2	Black		11	Analog GND	
	3	Red	11		+ VB	
	4	Blue		14	V reference	
Ch. 8	1	White		9	Analog input 8	450 mm
	2	Black		11	Analog GND	
	3	Red	11		+ VB	
	4	Blue		14	V reference	
Speed	1	White	12		Speed GND + VB	450 mm
	2	Black	10			
	3	Red	11			
	4	Blue				
USB	1	White		10	USB D+ GND USB D-	1000 mm
	2	Black	10			
	3	Red	7			
	4	n.c.				

Rif. / Ref.	Q.tà / Q.ty	Materiale / Material	N. articolo / Item N.		
Progettato da / Designed by L.I.		Contr. da / Ckd. by	Approvato da / Approved by	Nome file / File name	Data / Date
 Racing Data Power		Titolo / Title Cavo standard per MXL Pista ed optional per MXL Strada			
		N. disegno / Drawing N. 04.554.02		Rev. / Rev.	Foglio / Sheet 2 of 3

N.rev. / Rev. N.	Descrizione / Description	Data / date	Firma / Sign	Contr. da / Ckd. by
------------------	---------------------------	-------------	--------------	---------------------

Not cabled channels table

Channel	Cable colour	AMP 12 pin	Connection	Length
Power	Red	2	Vb ext (9-15 VDC) GND	500 mm
	Black	1		
RPM	White	8	RPM Coil - Square Wave	500 mm
CAN	White	4	CAN+ CAN-	500 mm
	Blue	3		
RS232	White	6	RS232RX RS232TX	500 mm
	Blue	5		

Rif. / Ref.	Q.tà / Q.ty	Materiale / Material	N. articolo / Item N.		
Progettato da / Designed by L.I.		Contr. da / Ckd. by	Approvato da / Approved by	Nome file / File name	Data / Date
 Racing Data Power		Titolo / Title Cavo standard per MXL Pista ed optional per MXL Strada			
		N. disegno / Drawing N. 04.554.02		Rev. / Rev.	Foglio / Sheet 3 of 3

N.rev. / Rev. N.	Descrizione / Description	Data / date	Firma / Sign	Contr. da / Ckd. by
------------------	---------------------------	-------------	--------------	---------------------

USB cable for data download - 3.5 mm stereo Jack

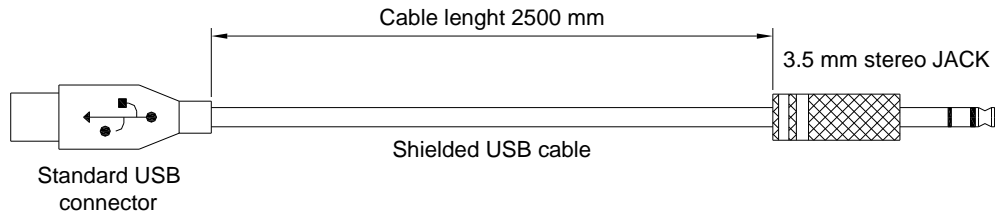

Pin connection

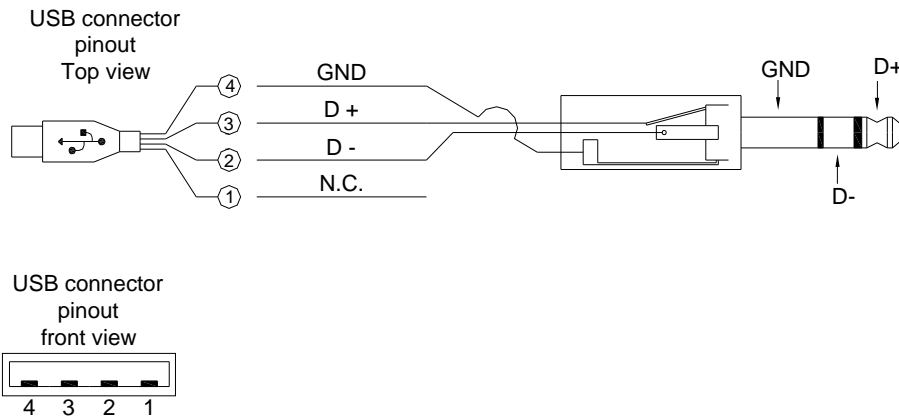

Rif. / Ref.	Q.tà / Q.ty	Materiale / Material	N. articolo / Item N.	
Progettato da / Designed by	Contr. da / Ckd. by	Approvato da / Approved by	Nome file / File name	Scala / Scale
		Titolo / Title		
		Cavo USB per scarico dati - Jack da 3.5 mm stereo		
N. disegno / Drawing N.		04.554.30	Rev. / Rev.	Foglio / Sheet
				1 of 1